

FUN-SPOT

ENGLISH VERSION

05/03/2020

Rev 1.8

FUN-SPOT

Fun-Spot 30

Fun-Spot 45

Fun-Spot 60

Fun-Spot 75

Fun-Spot 100

Fun-Spot is a family of round lamps, conceived to serve the amusement world and, in particular, the world of amusement rides.

The lamps are totally designed and produced in our factory in Italy with first choice materials such as the OSRAM LED, polyurethane resins and gold-plated connection contacts and they are intended for both an indoor and outdoor use. The body is made of Nylon and the lid in methacrylate, in order to grant the maximum transparency and resistance to the damaging effects of the UV rays. The electrical connection is based on commercial wires and the connection is fast and secure thanks to the isolation drilling technique. The whole family is available both in the direct wire connection with an extremely compact volume, and in the version with a special lamp socket for an easy and quick replacement.

The family is composed of 5 formats which differentiate in diameter: **30, 45, 60, 75 and 100 mm** and 3 operative modes: **Plug&Play, Controllable Pixel and Controllable SMART**. Due to technical limits, some modes and functions may not be available for some models.

The optoelectronics range from a minimum of 3 LEDs to a maximum of 60 LEDs according to the dimension of the lamp.

Each lamp can be supplied with RGB or Mono-Colour LEDs.

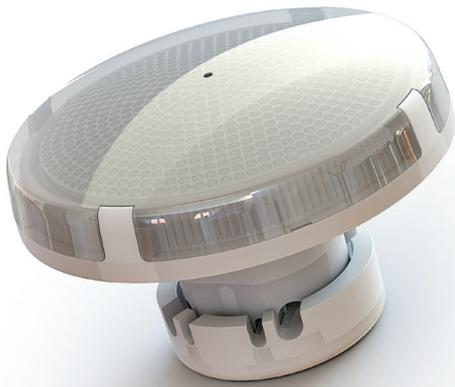

PLUG & PLAY

Fun-Led is a pioneer of the Plug&Play technology since the first years 2000. These lamps are characterized by electronics with internal programming which work without controller, just power supplied with alternating current through a standard ferromagnetic transformer. The lamp can be supplied pre-programmed, with standard sequences of 8 and 16 channels, with customized sequences, or virgin and programmable by the user without limits to the number of channels with a simple programming kit provided by Fun-Led.

The versions with 20 LEDs (size M), 30 LEDs (size L) and 60 LEDs (size XL) are divided into internal sections called chipset (each made up of 10 LEDs) in order to reproduce special light effects inside the lamp itself.

One of the main features of the Plug & Play operative mode is the huge onboard memory size. This characteristic, combined with our programming software, allows to create applications with numerous channels, thus obtaining unimagined choreographies for a Plug&Play system. Another important feature is the presence of a temperature sensor inside the lamp, which decreases its brightness in case the temperature exceeds a certain degree, thus protecting the LEDs from overheating when they are used in daylight in environments with extreme temperatures.

All the Plug&Play lamps can be supplied with RGB or Mono-Colour LEDs and equipped with the **Super Strobe** option.

CONTROLLABLE PIXEL

"Standard WS2811" protocol, adopted also by Fun-Led, based on a serial signal (SPI) which allows to manage the brightness and the colour of each single lamp. The lamps are not numbered and their cascaded connection must follow a precise path based on an initial project. The versions with 20 LEDs (size M), 30 LEDs (size L) and 60 LEDs (size XL) are divided into internal sections called chipset (each made up of 10 LEDs) in order to reproduce special light effects inside the lamp itself.

This operative mode requires a power supply with direct current and a controller board.

Fun-Led offers numerous hardware and software solutions to manage and control its own lamps at best.

All the Pixel lamps can be supplied with RGB and Mono-Colour LEDs and equipped with the **Enhanced** and the **Super Strobe** options.

CONTROLLABLE SMART

The brand-new SMART technology is a Fun-Led absolute and exclusive innovation, which enables to control the single LEDs of the lamp, in order to create light games inside the lamp itself for unique and amazing effects. This is possible thanks to the use of a Fun-Led own communication protocol. This technology is available for the versions with 20 LEDs (size M), 30 LEDs (size L) and 60 LEDs (size XL). The Smart lamps can work only combined with Fun-Led controller and software.

All the Smart lamps are available only with RGB LEDs, they are integrated with the **Enhanced** features and can be equipped with the **Super Strobe** option.

OPTIONAL FEATURES

SUPER STROBE OPTION

Absolute Fun-Led innovation which characterizes the lamps from diameter 45mm up to diameter 100mm in all the operative modes.

It consists in equipping the lamps with extremely bright white LEDs to grant a very powerful flashing effect integrated into the lamp itself. The intensity and the duration of the impulse can be set and programmed via software.

This characteristic increases the potential of our lamps, ensuring a strong visual impact and spectacular choreographies.

ENHANCED OPTION

Enhanced is a set of functions which is applied to the Controllable Pixel lamps from diameter 45mm up to 100mm to increase their performances, granting at the same time the absolute compatibility with the WS2811 protocol. That way, the lamps are made more flexible, efficient and unique. The same functions are integrated as default in the Smart operative mode.

In particular:

- It enables to manage and customize the duration of the **Super Strobe**, thus allowing to vary its intensity and frequency.
- **Thermal protection:** thanks to an internal temperature sensor, it is possible to limit the functioning of the lamp in case the temperature exceeds a certain limit, thus protecting the lamp when it is used in daylight in environments with extreme temperatures.
- **Emergency mode.** A common limit to all Pixel lamps is that, in case of absence of a correct control signal, the lamps are turned off. The Enhanced option overcomes this limit by turning on the lamps of a programmable colour and intensity if there is no correct control signal at power-up. With Enhanced the attraction will never be turned off!

As anticipated, the Pixel Enhanced lamps can be controlled with a standard controller compatible with the WS2811 protocol, but its default parameters can be reprogrammed only with a Fun-Led controller.

EXPLODED VIEWS

FUN-SPOT 45/60/75/100 mm

FUN-SPOT 30 mm



Direct Wire

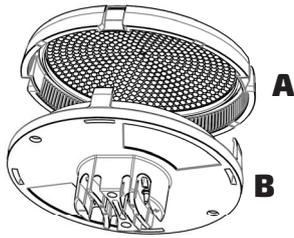

Direct Wire

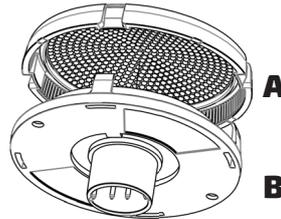

Frontal Pull Out
Model **D24**

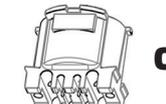
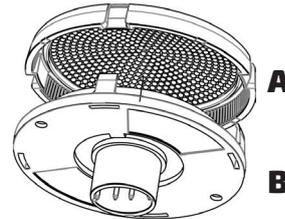

Frontal Pull Out
Model **R24**

A	LID
B	LIGHTING FIXTURE
C	SOCKET
D	SOCKET CAP

THE BASE

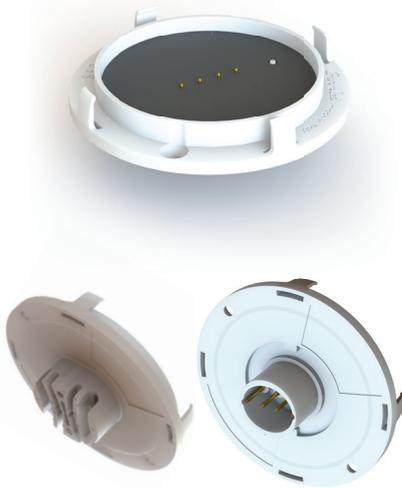

The Fun-Spot lamps are characterized by a strong structure housing the optoelectronics which is resined and forms the waterproof lighting fixture. The structure is made of Nylon charged with white color glass and grants strength, stability and resistance to all weather conditions and thermal changes. The structure can be supplied in other different colors upon request, in order to adapt to various themes. The connection modes to the electrical system are two: "Direct Wire" which provides the direct connection of the wires through the isolation drilling technique and "Frontal Pull Out" which uses a connector to be inserted into a lamp socket. The first solution grants an extremely compact volume and a reduced cost, the second one allows an easy removal of the lamp in case of replacement. In both connection modes the contacts are made of brass which is successively nickered and gold plated to assure the best contact and protection against oxidation. Four elastic hooks grant a secure, quick and strong fastening of the structure to the lid. The fixing to the support frame is made with two screws. Both the "Direct Wire" and the "Frontal Pull Out" version have a polarization which enables to control the orientation of the lamps during the installation. Due to its reduced sizes, the model with Ø 30mm is available only in the "Direct Wire" version and is integrated into its lid.

THE LID

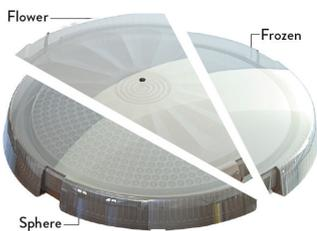

The lid is made of transparent methacrylate which prevents it from yellowing in case of UV exposure and assures an excellent resistance to bad weather conditions. Outside it is perfectly smooth in order to avoid the deposit of dust and dirt and to grant an easy cleaning. The lid is pressure mounted to the base for a quick installation. The standard inner pattern is the "Flower", then there are following options upon request: "Sphere", "Frozen" and "Transparent". These characteristics refer also to the smallest model (Ø 30mm), though this one is integrated into its base.

SOCKET



D24 Model

R24 Model

D24 and R24 are our new socket models. They consist of a body which can be with two or four isolation drilling contacts and a socket cap which drills the isolation of the wires through the tightening of two screws, thus making the electrical connection. A common characteristic to both socket models is the compact volume and the safety in making a good electrical connection. The body presents a polarization which helps in setting the correct orientation of the lamp on the support.

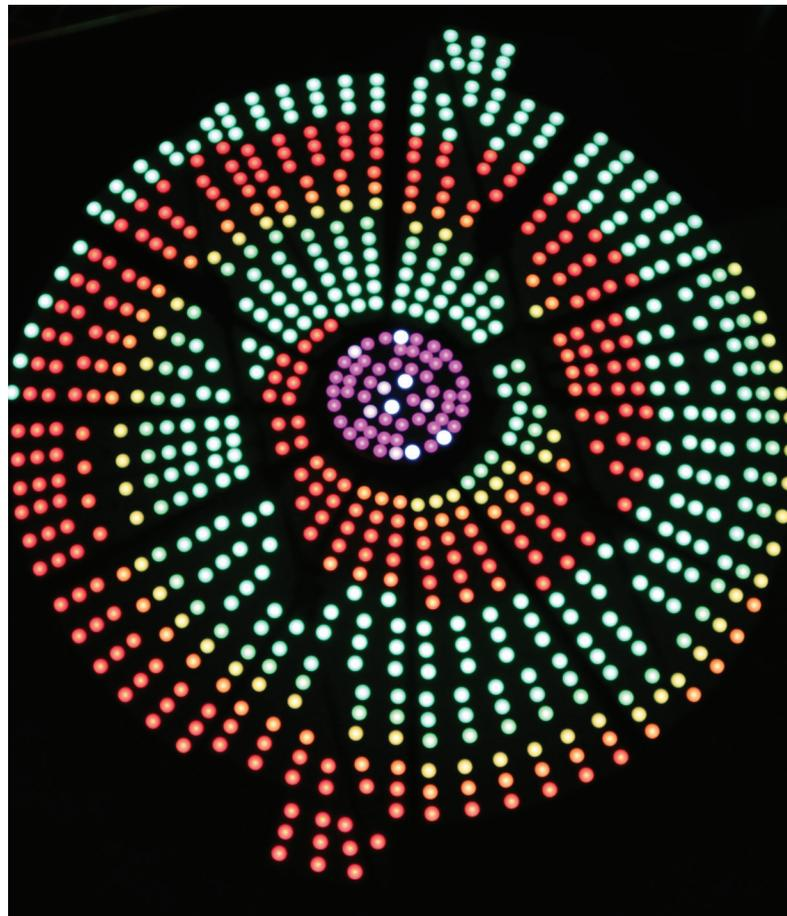



Fun-Spot 30 mm is the smallest model of the Fun-Spot family with diameter of 30 mm and is equipped with 3 LEDs. It is available in the Plug&Play and Controllable Pixel (not Enhanced) operative modes and only in the Direct Wire installation system with integrated lid.

Operative Mode	LED	Wire Connection	Supply Voltage	Rated Power	Rated Power Strobe	Options		
	n°	n°	Volt	Watt	Watt	Super Strobe (STRB) LED n°	Enhanced (E) Watt	
Plug&Play (PP)	3	2	9V AC	0,25	0,45	-	-	-
Controllable Pixel (PX)	3	4	12V DC	0,2 ¹	0,3 ²	1	0,4	-

¹Recommended maximum power

²Recommended maximum duration is of 50 ms with a duty cycle of 25%

SIZES

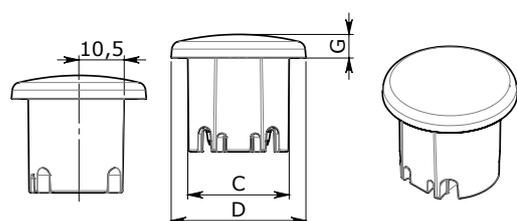

DIRECT WIRE - BASE

	D	C	G
mm	31,2	23,5	5,5

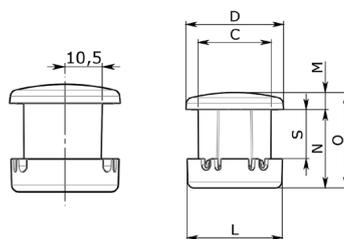

DIRECT WIRE - COMPLETE

	D	C	L	M	N	O	S
mm	31,2	23,5	30,5	5,5	25,2	30,8	15,9

DRILLING SCHEME TEMPLATE

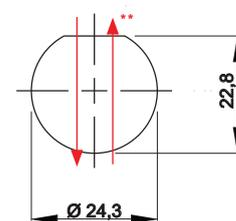

**: Cables

OPTIONS & CREATION OF THE CODE
PLUG&PLAY

A	B	C	D	E	F	G	H	I	J
Family	Operative Mode	Lighting Fixture	Base Colour	Circuit Size	LED Colour	Chipset N°	Supply Voltage	Lid Type	
9-Fun-Led	0-Fun-Spot	0-Plug&Play (PP)	5-Direct Wire 30mm	0-White°	0-XS (3 LED)	0-RGB	A-1	1-9V AC	0-Flower
						1-Cold White*			1-Frozen*
						2-Warm White*			2-Sphere*
						3-Red*			3-Transparent*
						4-Green*			
						5-Blue*			

CONTROLLABLE PIXEL

A	B	C	D	E	F	G	H	I	J
Family	Operative Mode	Lighting Fixture	Base Colour	Circuit Size	LED Colour	Chipset N°	Supply Voltage	Lid Type	
9-Fun-Led	0-Fun-Spot	2-Pixel (PX)	5-Direct Wire 30mm	0-White°	0-XS (3 LED)	0-RGB	A-1	2-12V DC	0-Flower
						1-Cold White*			1-Frozen*
						2-Warm White*			2-Sphere*
						3-Red*			3-Transparent*
						4-Green*			
						5-Blue*			

°OTHER COLOURS UPON REQUEST

*OPTIONAL UPON REQUEST

EXAMPLES

“CODE: 900.5000A10 - FUN-SPOT D30 PP 3-1-9 XS RGB DIRECT WIRE + FLW”:

Type of Lamp	Diameter (Ø)	Operative Mode	Strobe	Led N°	Chipset N°	Supply Voltage	P. B. Size	Colour	Lighting Fixture	Lid
FUN-SPOT	30	PP	-	3	1	9V AC	XS	RGB	DIRECT WIRE	FLW

The above data may undergo variations

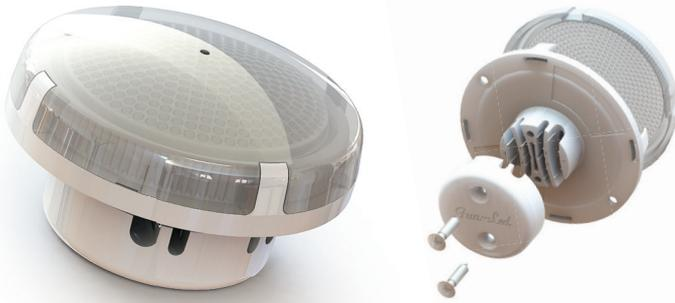

Fun-Spot 45 mm is a lamp with diameter of 45mm and is equipped with 10 LEDs. It is available in the Plug&Play and Controllable Pixel operative modes and in both the Direct Wire and Frontal Pull Out installation systems. It is one of our best-sellers thanks to the easiness of fitting many different subjects.

Operative Mode	LED	Wire Connection	Supply Voltage	Rated Power	Rated Power Strobe	Options			
						Super Strobe (STRB)			Enhanced (E)
						LED n°	Watt	Strobe+STRB Watt	
Plug&Play (PP)	10	2	24V AC	0,75	1,5	3	2,5	4	-
Controllable Pixel (PX)	10	4	36V DC	0,9 ¹	1,95 ²	3	5,5 ³	7,45 ³	√

¹Recommended maximum power

²Recommended maximum duration is of 50 ms with a duty cycle of 25%

³Maximum programmable duration is of 50 ms with a duty cycle of 25%

SIZES

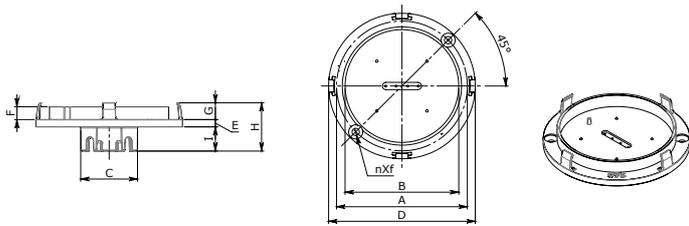

DIRECT WIRE - BASE

mm	D	A	B	C	E	F	G	H	I	nXf
	45	38,5	31,8	23,5	3	5,3	6	19	10	2XØ3

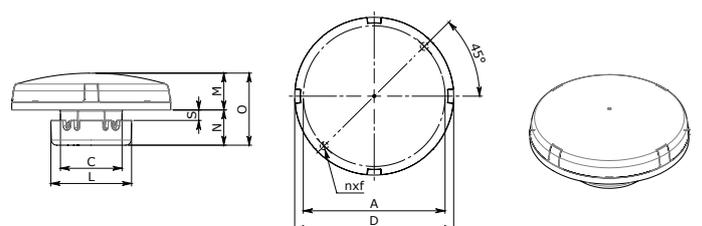

DIRECT WIRE - COMPLETE

mm	D	A	C	L	M	N	O	S	nXf
	45	38,5	23,5	30,5	13	13,4	26,4	4	2XØ3

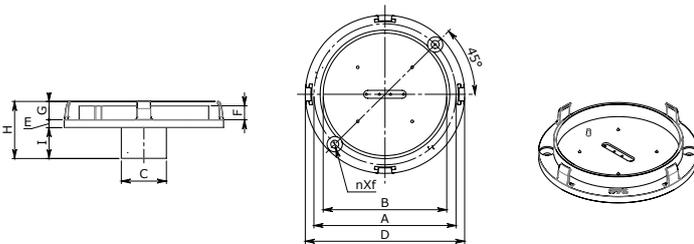

FRONTAL PULL OUT - BASE

mm	D	A	B	C	E	F	G	H	I	nXf
	45	38,5	31,8	17	3	5,3	6	20,7	11,7	2XØ3

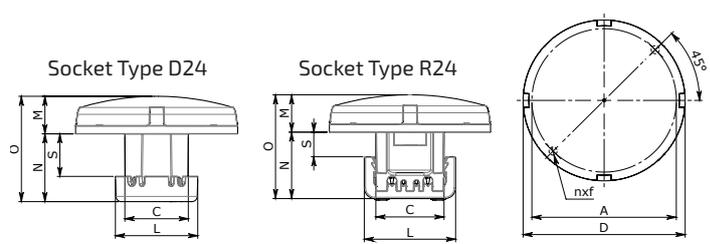

FRONTAL PULL OUT - COMPLETE

	D	A	C	L	M	N	O	S	nXf
D24 mm	45	38,5	23,5	30,5	14	25,3	39,3	15,9	2XØ3
R24 mm	45	38,5	23,5	30,5	13	25	38	9,3	2XØ3

LID

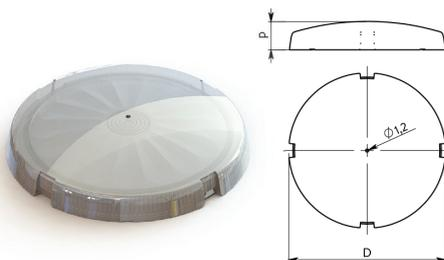

mm	D	P
	45	10

DRILLING SCHEME TEMPLATE

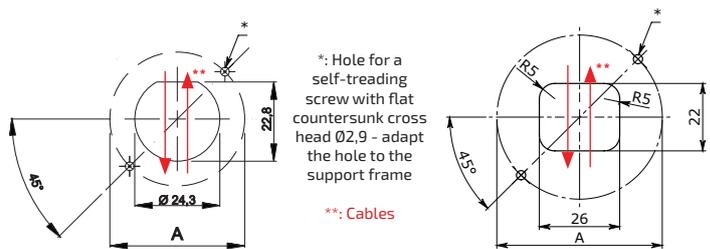

Socket Type D24

mm	A
	38,5

Socket Type R24

OPTIONS & CREATION OF THE CODE

PLUG&PLAY

A	B	C	D	E	F	G	H	I	J
	Family	Operative Mode	Lighting Fixture	Base Colour	Circuit Size	LED Colour	Chipset N°	Supply Voltage	Lid Type
9-Fun-Led	0-Fun-Spot	0-Plug&Play (PP)	1-Frontal Pull Out 45mm Socket D24	0-White°	1-5 (10 LED)	0-RGB	A-1	3-24V AC	0-Flower
		1-Plug&Play+ Super Strobe (PP+STRB)	6-Direct Wire 45mm			1-Cold White*			1-Frozen*
			B-Frontal Pull Out 45mm Socket R24			2-Warm White*			2-Sphere*
						3-Red*			3-Transparent*
						4-Green*			
						5-Blue*			

CONTROLLABLE PIXEL

A	B	C	D	E	F	G	H	I	J
	Family	Operative Mode	Lighting Fixture	Base Colour	Circuit Size	LED Colour	Chipset N°	Supply Voltage	Lid Type
9-Fun-Led	0-Fun-Spot	2-Pixel (PX)	1-Frontal Pull Out 45mm Socket D24	0-White°	1-5 (10 LED)	0-RGB	A-1	4-36V DC	0-Flower
		5-Pixel + Super Strobe (PX+STRB)	6-Direct Wire 45mm			1-Cold White*			1-Frozen*
		6-Pixel Enhanced (PX-E)	B-Frontal Pull Out 45mm Socket R24			2-Warm White*			2-Sphere*
		7-Pixel Enhanced+Super Strobe (PX-E+STRB)				3-Red*			3-Transparent*
						4-Green*			
						5-Blue*			

°OTHER COLOURS UPON REQUEST

*OPTIONAL UPON REQUEST

EXAMPLES

“CODE: 900.1010A30 - FUN-SPOT D45 PP 10-1-24 S RGB FRONTAL PULL OUT D24 + FLW”:

Type of Lamp	Diameter (Ø)	Operative Mode	Strobe	Led N°	Chipset N°	Supply Voltage	P. B. Size	Colour	Lighting Fixture	Lid
FUN-SPOT	45	PP	-	10	1	24V AC	S	RGB	FRONTAL P.O. D24	FLW

“CODE: 905.6010A40 - FUN-SPOT D45 PX+STRB 10-1-36 S RGB DIRECT WIRE + FLW”:

Type of Lamp	Diameter (Ø)	Operative Mode	Strobe	Led N°	Chipset N°	Supply Voltage	P. B. Size	Colour	Lighting Fixture	Lid
FUN-SPOT	45	PX	STRB	10	1	36V DC	S	RGB	DIRECT WIRE	FLW

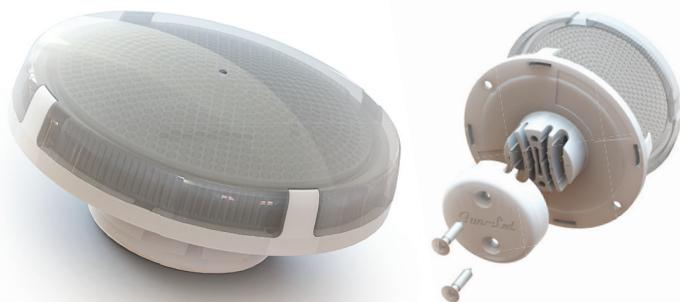

Fun-Spot 60 mm is a lamp with diameter of 60 mm, whose base can be equipped with 10 or 20 LEDs according to the power level you want to obtain. It is available in all the three operative modes (Plug&Play, Controllable Pixel and Controllable SMART) and in both the Direct Wire and Frontal Pull Out installation systems. It is one of our best-sellers thanks to the easiness of fitting many different subjects.

Operative Mode	LED	Wire Connection	Supply Voltage	Rated Power	Rated Power Strobe	Options			
						Super Strobe (STRB)			Enhanced (E)
						LED n°	Watt	Strobe+STRB Watt	
Plug&Play (PP)	10	2	24V AC	0,7	1,5	3	2,5	4	-
	20			1,25	3	6	3	6	-
Controllable Pixel (PX)	10	4	36V DC	0,9 ¹	1,95 ²	3	5,5 ³	7,45 ³	✓
	20			1,8 ¹	3,9 ²	6	7,9 ³	11,8 ³	✓
Controllable Smart (SMART)	20	4	24V DC	1,35	3	6	5	8	-

¹Recommended maximum power

²Recommended maximum duration is of 50 ms with a duty cycle of 25%

³Maximum programmable duration is of 50 ms with a duty cycle of 25%

SIZES

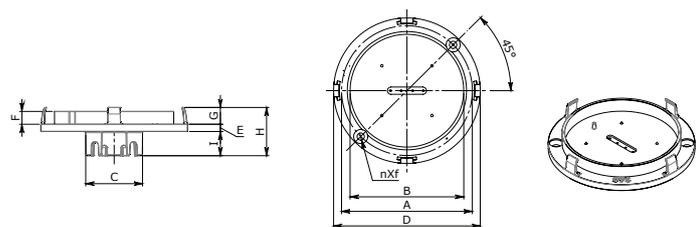

DIRECT WIRE - BASE

mm	D	A	B	C	E	F	G	H	I	nXf
	60	53,5	46,5	23,5	3	5,3	6,9	19,9	10	2XØ3

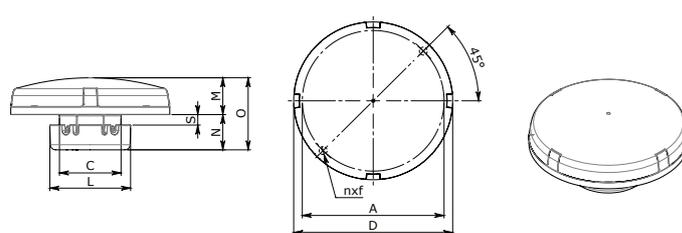

DIRECT WIRE - COMPLETE

mm	D	A	C	L	M	N	O	S	nXf
	60	53,5	23,5	30,5	13	13,4	26,4	4	2XØ3

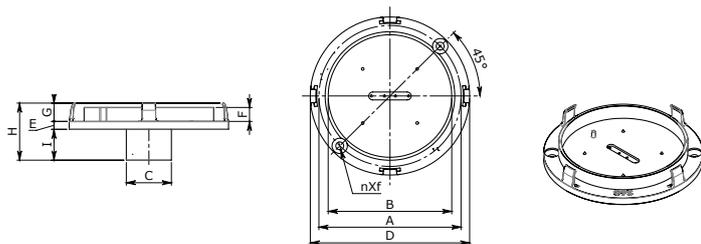

FRONTAL PULL OUT - BASE

mm	D	A	B	C	E	F	G	H	I	nXf
	60	53,5	46,5	17	3	5,3	6,9	21,6	11,7	2XØ3

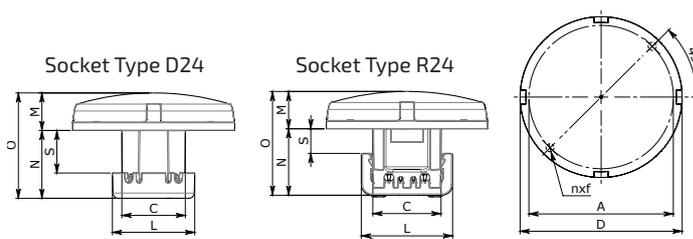

FRONTAL PULL OUT - COMPLETE

	D	A	C	L	M	N	O	S	nXf
D24 mm	60	53,5	23,5	30,5	14	25,3	39,3	15,9	2XØ3
R24 mm	60	53,5	23,5	30,5	14	25	39	9,3	2XØ3

LID

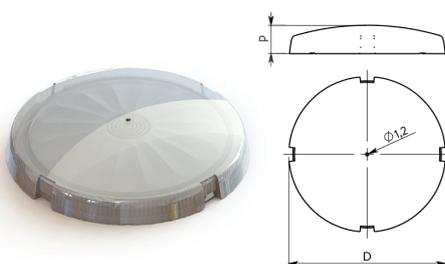

mm	D	P
	60	11

DRILLING SCHEME TEMPLATE

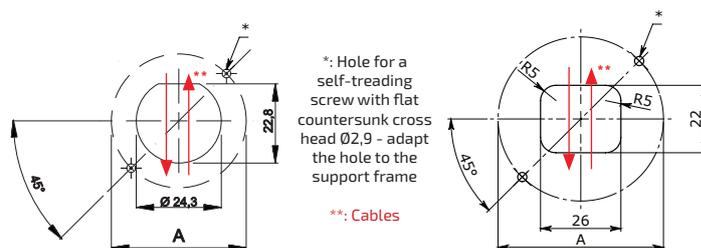

Socket Type D24

mm	A
	53,5

Socket Type R24

OPTIONS & CREATION OF THE CODE

PLUG&PLAY

A	B	C	D	E	F	G	H	I	J
	Family	Operative Mode	Lighting Fixture	Base Colour	Circuit Size	LED Colour	Chipset N°	Supply Voltage	Lid Type
9-Fun-Led	0-Fun-Spot	0-Plug&Play (PP)	2-Frontal Pull Out 60mm Socket D24	0-White °	1-S (10 LED)	0-RGB	A-1	3-24V AC	0-Flower
		1-Plug&Play+ Super Strobe (PP+STRB)	7-Direct Wire 60mm		2-M (20 LED)	1-Cold White*	B-2		1-Frozen*
			C-Frontal Pull Out 60mm Socket R24			2-Warm White*			2-Sphere*
						3-Red*			3-Transparent*
						4-Green*			
						5-Blue*			

CONTROLLABLE PIXEL

A	B	C	D	E	F	G	H	I	J
	Family	Operative Mode	Lighting Fixture	Base Colour	Circuit Size	LED Colour	Chipset N°	Supply Voltage	Lid Type
9-Fun-Led	0-Fun-Spot	2-Pixel (PX)	2-Frontal Pull Out 60mm Socket D24	0-White °	1-S (10 LED)	0-RGB	A-1	4-36V DC	0-Flower
		5-Pixel + Super Strobe (PX+STRB)	7-Direct Wire 60mm		2-M (20 LED)	1-Cold White*	B-2		1-Frozen*
		6-Pixel Enhanced (PX-E)	C-Frontal Pull Out 60mm Socket R24			2-Warm White*			2-Sphere*
		7-Pixel Enhanced+Super Strobe (PX-E+STRB)				3-Red*			3-Transparent*
						4-Green*			
						5-Blue*			

CONTROLLABLE SMART

A	B	C	D	E	F	G	H	I	J
	Family	Operative Mode	Lighting Fixture	Base Colour	Circuit Size	LED Colour	Chipset N°	Supply Voltage	Lid Type
9-Fun-Led	0-Fun-Spot	3-Smart (SMART)	2-Frontal Pull Out 60mm Socket D24	0-White °	2-M (20 LED)	0-RGB	E-20	5-24V DC	0-Flower
		4-Smart + Super Strobe (SMART+STRB)	7-Direct Wire 60mm						1-Frozen*
			C-Frontal Pull Out 60mm Socket R24						2-Sphere*
									3-Transparent*

°OTHER COLOURS UPON REQUEST

*OPTIONAL UPON REQUEST

EXAMPLES

"CODE: 900.2020B30 - FUN-SPOT D60 PP 20-2-24 M RGB FRONTAL PULL OUT D24 + FLW":

Type of Lamp	Diameter (∅)	Operative Mode	Strobe	Led N°	Chipset N°	Supply Voltage	P. B. Size	Colour	Lighting Fixture	Lid
FUN-SPOT	60	PP	-	20	2	24V AC	M	RGB	FRONTAL P.O. D24	FLW

"CODE: 907.7020B40 - FUN-SPOT D60 PX-E+STRB 20-2-36 M RGB DIRECT WIRE + FLW":

Type of Lamp	Diameter (∅)	Operative Mode	Strobe	Led N°	Chipset N°	Supply Voltage	P. B. Size	Colour	Lighting Fixture	Lid
FUN-SPOT	60	PX-E	STRB	20	2	36V DC	M	RGB	DIRECT WIRE	FLW

"CODE: 904.C020E50 - FUN-SPOT D60 SMART+STRB 20-20-24 M RGB FRONTAL PULL OUT R24+ FLW":

Type of Lamp	Diameter (∅)	Operative Mode	Strobe	Led N°	Chipset N°	Supply Voltage	P. B. Size	Colour	Lighting Fixture	Lid
FUN-SPOT	60	SMART	STRB	20	20	24V DC	M	RGB	FRONTAL P.O. R24	FLW

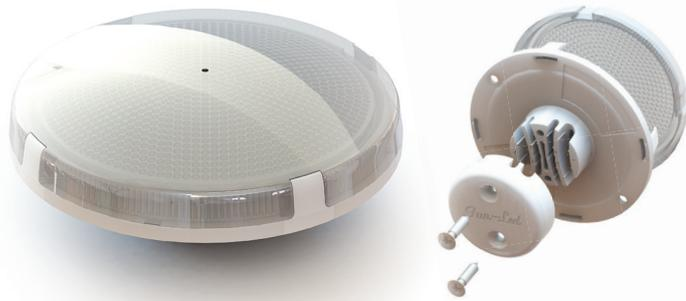

Fun-Spot 75 mm is a lamp with diameter of 75mm, whose base can be equipped with 20 or 30 LEDs according to the power level you want to obtain. It is available in all the three operative modes (Plug&Play, Controllable Pixel and Controllable SMART) and in both the Direct Wire and Frontal Pull Out installation systems.

Operative Mode	LED	Wire Connection	Supply Voltage	Rated Power	Rated Power Strobe	Options			
						Super Strobe (STRB)			Enhanced (E)
						LED n°	Watt	Strobe+STRB Watt	
Plug&Play (PP)	20	2	24V AC	1,25	3	6	3	6	-
	30			1,75	5	6	3	8	-
Controllable Pixel (PX)	20	4	36V DC	1,8 ¹	3,9 ²	6	7,9 ³	11,8 ³	✓
	30			2,7 ¹	5,85 ²	6	7,9 ³	13,75 ³	✓
Controllable Smart (SMART)	20	4	24V DC	1,35	3	6	5	8	-
	30			1,9	5	6	5	10	-

¹Recommended maximum power

²Recommended maximum duration is of 50 ms with a duty cycle of 25%

³Maximum programmable duration is of 50 ms with a duty cycle of 25%

SIZES

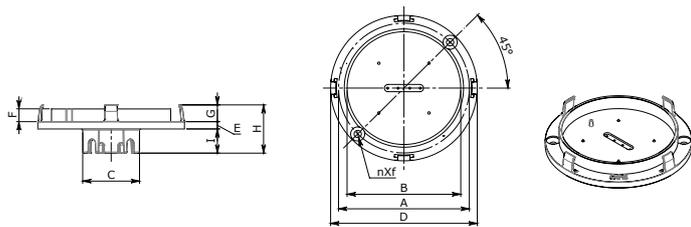

DIRECT WIRE - BASE

mm	D	A	B	C	E	F	G	H	I	nXf
	75	68,5	61,5	23,5	3	5,3	6,9	19,9	10	2XØ3

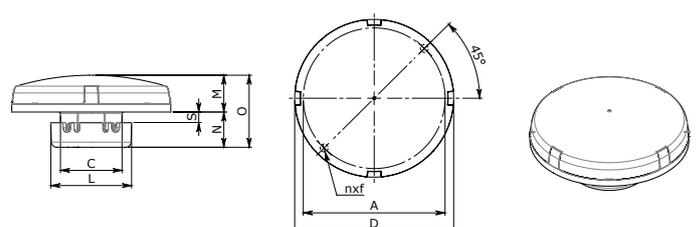

DIRECT WIRE - COMPLETE

mm	D	A	C	L	M	N	O	S	nXf
	75	68,5	23,5	30,5	15	13,4	28,4	4	2XØ3

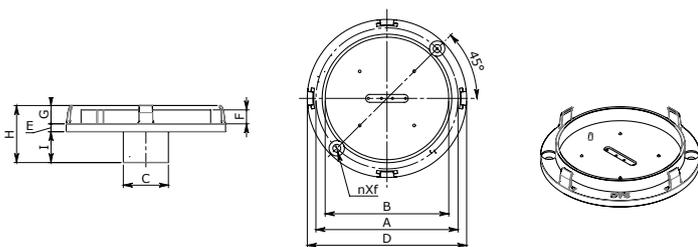

FRONTAL PULL OUT - BASE

mm	D	A	B	C	E	F	G	H	I	nXf
	75	68,5	61,5	17	3	5,3	6,9	21,6	11,7	2XØ3

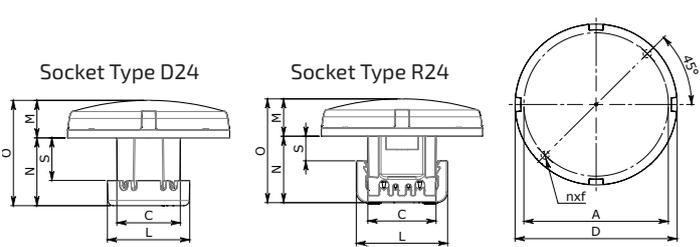

FRONTAL PULL OUT - COMPLETE

		D	A	C	L	M	N	O	S	nXf
D24	mm	75	68,5	23,5	30,5	15	25,3	40,3	15,9	2XØ3
R24	mm	75	68,5	23,5	30,5	15	25	40	9,3	2XØ3

LID

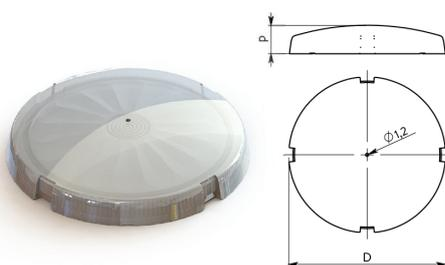

mm	D	P
	75	12

DRILLING SCHEME TEMPLATE

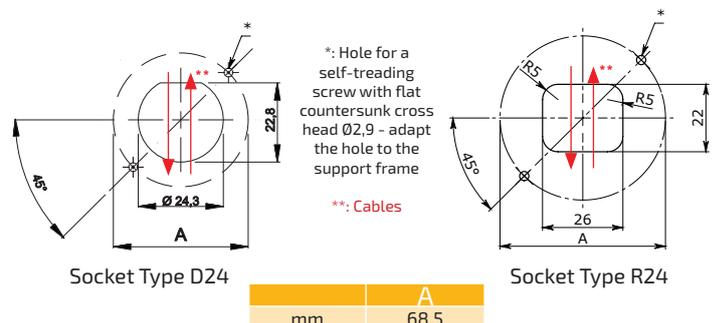

mm	A
	68,5

OPTIONS & CREATION OF THE CODE

PLUG&PLAY

A	B	C	D	E	F	G	H	I	J
	Family	Operative Mode	Lighting Fixture	Base Colour	Circuit Size	LED Colour	Chipset N°	Supply Voltage	Lid Type
9-Fun-Led	0-Fun-Spot	0-Plug&Play (PP)	3-Frontal Pull Out 75mm Socket D24	0-White [°]	2-M (20 LED)	0-RGB	B-2	3-24V AC	0-Flower
		1-Plug&Play+ Super Strobe (PP+STRB)	8-Direct Wire 75mm		3-L (30 LED)	1-Cold White*	C-3		1-Frozen*
			D-Frontal Pull Out 75mm Socket R24			2-Warm White*			2-Sphere*
						3-Red*			3-Transparent*
						4-Green*			
						5-Blue*			

CONTROLLABLE PIXEL

A	B	C	D	E	F	G	H	I	J
	Family	Operative Mode	Lighting Fixture	Base Colour	Circuit Size	LED Colour	Chipset N°	Supply Voltage	Lid Type
9-Fun-Led	0-Fun-Spot	2-Pixel (PX)	3-Frontal Pull Out 75mm Socket D24	0-White [°]	2-M (20 LED)	0-RGB	B-2	4-36V DC	0-Flower
		5-Pixel + Super Strobe (PX+STRB)	8-Direct Wire 75mm		3-L (30 LED)	1-Cold White*	C-3		1-Frozen*
		6-Pixel Enhanced (PX-E)	D-Frontal Pull Out 75mm Socket R24			2-Warm White*			2-Sphere*
		7-Pixel Enhanced+Super Strobe (PX-E+STRB)				3-Red*			3-Transparent*
						4-Green*			
						5-Blue*			

CONTROLLABLE SMART

A	B	C	D	E	F	G	H	I	J
	Family	Operative Mode	Lighting Fixture	Base Colour	Circuit Size	LED Colour	Chipset N°	Supply Voltage	Lid Type
9-Fun-Led	0-Fun-Spot	3-Smart (SMART)	3-Frontal Pull Out 75mm Socket D24	0-White [°]	2-M (20 LED)	0-RGB	E-20	5-24V DC	0-Flower
		4-Smart + Super Strobe (SMART+STRB)	8-Direct Wire 75mm		3-L (30 LED)		F-30		1-Frozen*
			D-Frontal Pull Out 75mm Socket R24						2-Sphere*
									3-Transparent*

[°]OTHER COLOURS UPON REQUEST

*OPTIONAL UPON REQUEST

EXAMPLES

CODE: 900.3020B30 - FUN-SPOT D75 PP 20-2-24 M RGB FRONTAL PULL OUT D24 + FLW":

Type of Lamp	Diameter (Ø)	Operative Mode	Strobe	Led N°	Chipset N°	Supply Voltage	P. B. Size	Colour	Lighting Fixture	Lid
FUN-SPOT	75	PP	-	20	2	24V AC	M	RGB	FRONTAL P.O. D24	FLW

CODE: 907.8020B40 - FUN-SPOT D75 PX-E+STRB 20-2-36 M RGB DIRECT WIRE + FLW":

Type of Lamp	Diameter (Ø)	Operative Mode	Strobe	Led N°	Chipset N°	Supply Voltage	P. B. Size	Colour	Lighting Fixture	Lid
FUN-SPOT	75	PX-E	STRB	20	2	36V DC	M	RGB	DIRECT WIRE	FLW

CODE: 904.D030F50 - FUN-SPOT D75 SMART+STRB 30-30-24 L RGB FRONTAL PULL OUT R24 + FLW":

Type of Lamp	Diameter (Ø)	Operative Mode	Strobe	Led N°	Chipset N°	Supply Voltage	P. B. Size	Colour	Lighting Fixture	Lid
FUN-SPOT	75	SMART	STRB	30	30	24V DC	L	RGB	FRONTAL P.O. R24	FLW

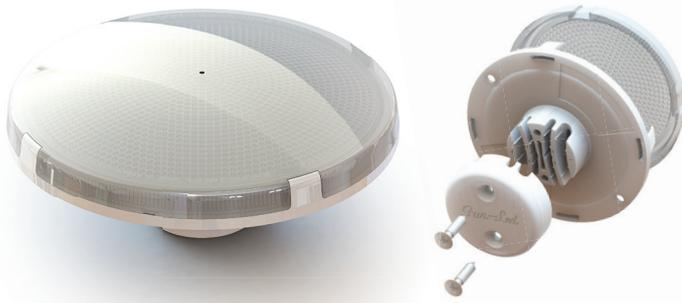

Fun-Spot 100 mm is the biggest model of the Fun-Spot family with diameter of 100 mm and its base can be equipped with 30 or 60 LEDs according to the power level you want to obtain. It is available in all the three operative modes (Plug&Play, Controllable Pixel and Controllable SMART) and in the Frontal Pull Out version only.

Operative Mode	LED	Wire Connection	Supply Voltage	Rated Power	Rated Power Strobe	Options			
						Super Strobe (STRB)			Enhanced (E)
						LED n°	Watt	Strobe+STRB Watt	
Plug&Play (PP)	30	2	24V AC	1,75	5	6	3	8	-
	60			3,5	10	12	6	16	-
Controllable Pixel (PX)	30	4	36V DC	2,7 ¹	5,85 ²	6	7,9 ³	13,75 ³	√
	60			5,35 ¹	11,7 ²	12	15,8 ³	27,5 ³	√
Controllable Smart (SMART)	30	4	24V DC	1,9	5	6	5	10	-
	60			3,6	10	12	10	20	-

¹Recommended maximum power

²Recommended maximum duration is of 50 ms with a duty cycle of 25%

³Maximum programmable duration is of 50 ms with a duty cycle of 25%

SIZES

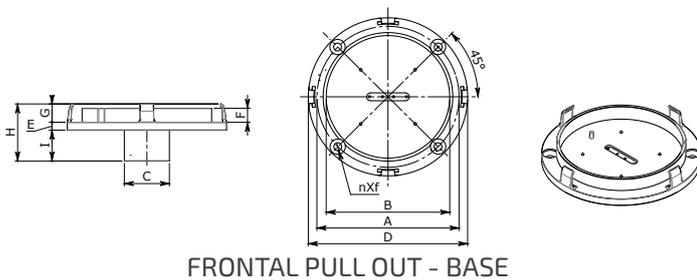

FRONTAL PULL OUT - BASE

mm	D	A	B	C	E	F	G	H	I	nXf
	100	93,5	86	17	3	5,3	6,9	21,6	11,7	4XØ3

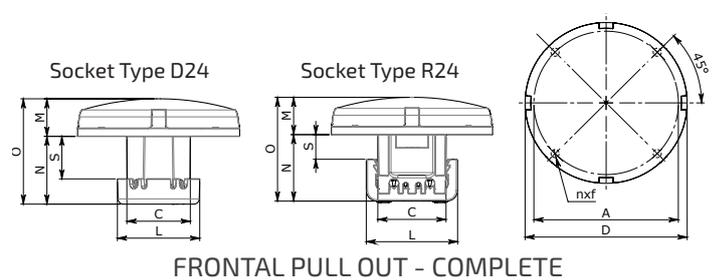

FRONTAL PULL OUT - COMPLETE

	D	A	C	L	M	N	O	S	nXf
D24 mm	100	93,5	23,5	30,5	16	25,3	41,3	15,9	4XØ3
R24 mm	100	93,5	23,5	30,5	16	25	41	9,3	4XØ3

LID

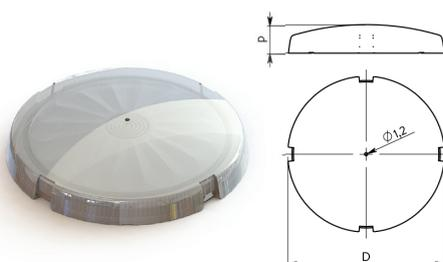

mm	D	P
	100	13

DRILLING SCHEME TEMPLATE

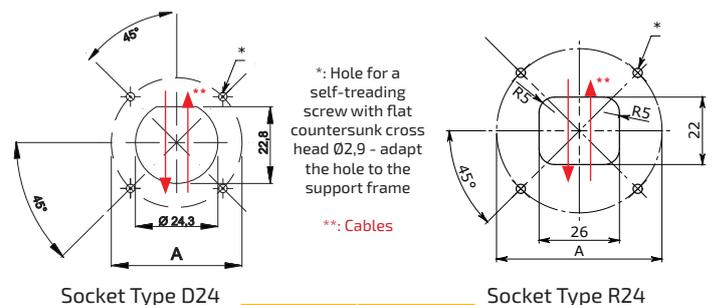

*: Hole for a self-treading screw with flat countersunk cross head Ø2,9 - adapt the hole to the support frame
 **: Cables

Socket Type D24

mm	A
	93,5

Socket Type R24

OPTIONS & CREATION OF THE CODE

PLUG&PLAY

A	B	C	D	E	F	G	H	I	J
	Family	Operative Mode	Lighting Fixture	Base Colour	Circuit Size	LED Colour	Chipset N°	Supply Voltage	Lid Type
9-Fun-Led	0-Fun-Spot	0-Plug&Play (PP)	4-Frontal Pull Out 100mm Socket D24	0-White°	3-L (30 LED)	0-RGB	C-3	3-24V AC	0-Flower
		1-Plug&Play+ Super Strobe (PP+STRB)	9-Direct Wire 100mm*		4-XL (60 LED)	1-Cold White*	D-6		1-Frozen*
			E-Frontal Pull Out 100mm Socket R24			2-Warm White			2-Sphere*
						3-Red*			3-Transparent*
						4-Green*			
						5-Blue*			

CONTROLLABLE PIXEL

A	B	C	D	E	F	G	H	I	J
	Family	Operative Mode	Lighting Fixture	Base Colour	Circuit Size	LED Colour	Chipset N°	Supply Voltage	Lid Type
9-Fun-Led	0-Fun-Spot	2-Pixel (PX)	4-Frontal Pull Out 100mm Socket D24	0-White°	3-L (30 LED)	0-RGB	C-3	4-36V DC	0-Flower
		5-Pixel + Super Strobe (PX+STRB)	9-Direct Wire 100mm*		4-XL (60 LED)	1-Cold White*	D-6		1-Frozen*
		6-Pixel Enhanced (PX-E)	E-Frontal Pull Out 100mm Socket R24			2-Warm White*			2-Sphere*
		7-Pixel Enhanced+Super Strobe (PX-E+STRB)				3-Red*			3-Transparent*
						4-Green*			
						5-Blue*			

CONTROLLABLE SMART

A	B	C	D	E	F	G	H	I	J
	Family	Operative Mode	Lighting Fixture	Base Colour	Circuit Size	LED Colour	Chipset N°	Supply Voltage	Lid Type
9-Fun-Led	0-Fun-Spot	3-Smart (SMART)	4-Frontal Pull Out 100mm Socket D24	0-White°	3-L (30 LED)	0-RGB	F-30	5-24V DC	0-Flower
		4-Smart + Super Strobe (SMART+STRB)	E-Frontal Pull Out 100mm Socket R24		4-XL (60 LED)		G-60		1-Frozen*
									2-Sphere*
									3-Transparent*

°OTHER COLOURS UPON REQUEST

*OPTIONAL UPON REQUEST

EXAMPLES

CODE: 900.4040D30 - FUN-SPOT D100 PP 60-6-24 XL RGB FRONTAL PULL OUT D24 + FLW:

Type of Lamp	Diameter (∅)	Operative Mode	Strobe	Led N°	Chipset N°	Supply Voltage	P. B. Size	Colour	Lighting Fixture	Lid
FUN-SPOT	100	PP	-	60	6	24V AC	XL	RGB	FRONTAL P.O. D24	FLW

CODE: 907.4030C40 - FUN-SPOT D100 PX-E+STRB 30-3-36 L RGB FRONTAL PULL OUT D24 + FLW:

Type of Lamp	Diameter (∅)	Operative Mode	Strobe	Led N°	Chipset N°	Supply Voltage	P. B. Size	Colour	Lighting Fixture	Lid
FUN-SPOT	100	PX-E	STRB	30	3	36V DC	L	RGB	FRONTAL P.O. D24	FLW

CODE: 904.E040G50 - FUN-SPOT D100 SMART+STRB 60-60-24 XL RGB FRONTAL PULL OUT R24+ FLW:

Type of Lamp	Diameter (∅)	Operative Mode	Strobe	Led N°	Chipset N°	Supply Voltage	P. B. Size	Colour	Lighting Fixture	Lid
FUN-SPOT	100	SMART	STRB	60	60	24V DC	XL	RGB	FRONTAL P.O. R24	FLW



www.fun-led.com - info@fun-led.com

LOSI FRANCESCO ELETTRONICA INDUSTRIALE
45037 - MELARA (RO) - Italy - Via Corno, 16 - Tel. +39 0425 89292 - Fax +39 0425 89730
Cod. Fiscale LSO FNC 54516 F095D - P. IVA 00273160291 - R.E.A. RO 78086 - Registro Imprese RO 19969614